

No.101 Track System



*Door panel is for reference only and is not included. Color may vary from the images

Leveraging more than 120 years of heritage, our No.101 sliding door track systems have been re-engineered for the 21st-century consumer to assure authentic and lasting architectural significance. These commercial quality hardware systems are available in two standard lengths and can accommodate 1-3/8" to 1-3/4" thick doors weighing up to 175lbs when installed properly. Each system is individually packaged and includes a 1" diameter track assembly with mounting brackets, No.1 cast iron door hangers, soft-stop system, blade style floor guide and installation hardware.

<u>item#</u>	<u>Size</u>	<u>Color</u>	<u>Application Description</u>
310-10-170	78" track	Satin Black	Designed for finished openings 36" wide and under
310-10-230	84" track	Satin Black	Designed for finished openings 42" wide and under
310-11-170*	78" track	Satin Brass	Designed for finished openings 36" wide and under
310-11-230*	84" track	Satin Brass	Designed for finished openings 42" wide and under

Satin Black Powdercoat

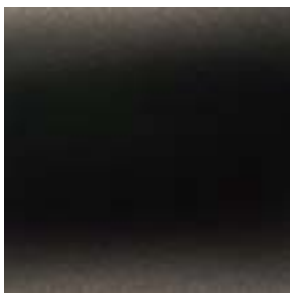

Satin Brass Powdercoat



*Satin Brass color is only available for bulk orders exceeding 100 sets.

Hospitality Sales
 Source Direct Imports
 Kip Richards
 kip@sourcedirectimports.com
 602.956.1149

General Sales & Inquires
 IndustrialBrands
 sales@industrialbrands.com
 602.767.4455

An Industrial Brands Company
www.industrialbrands.com

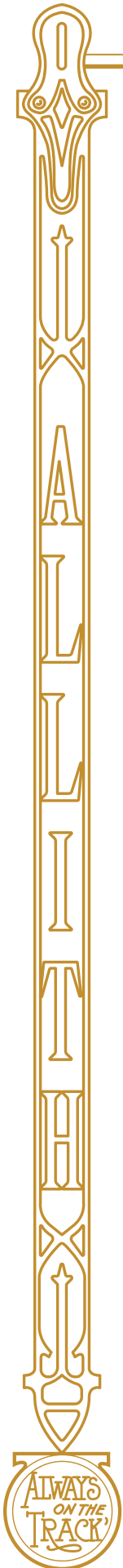

No.101 Track System

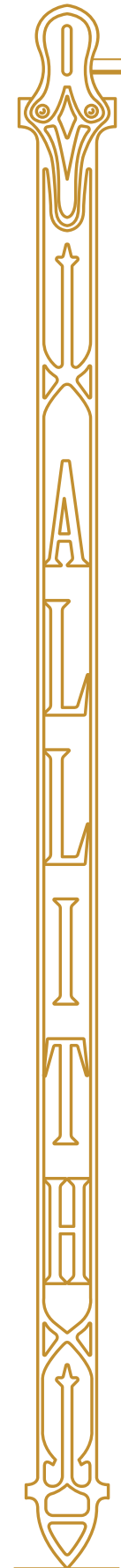
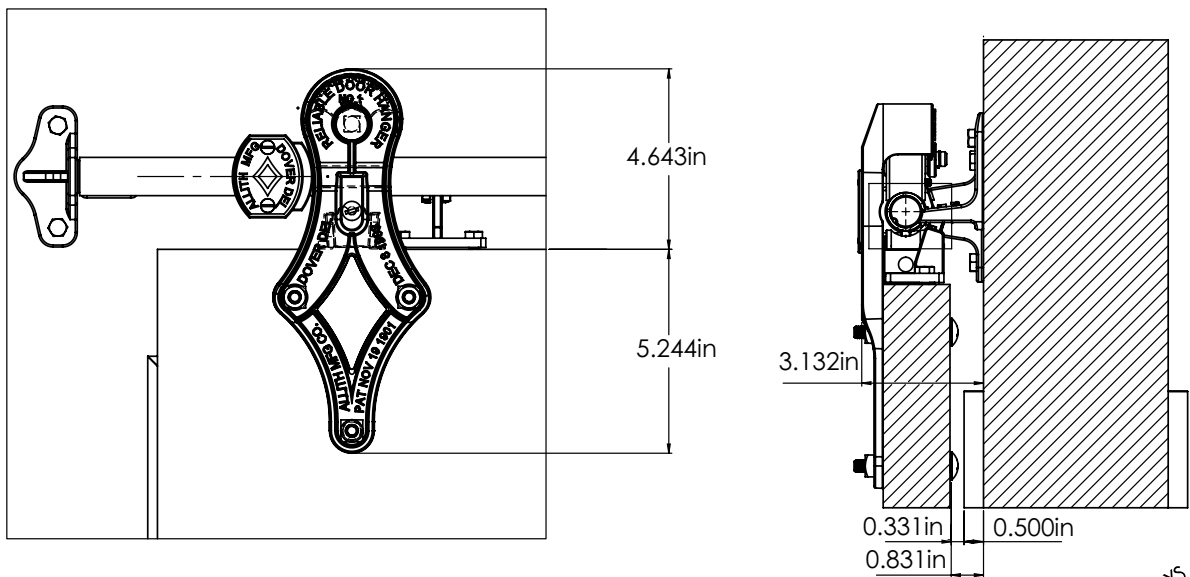
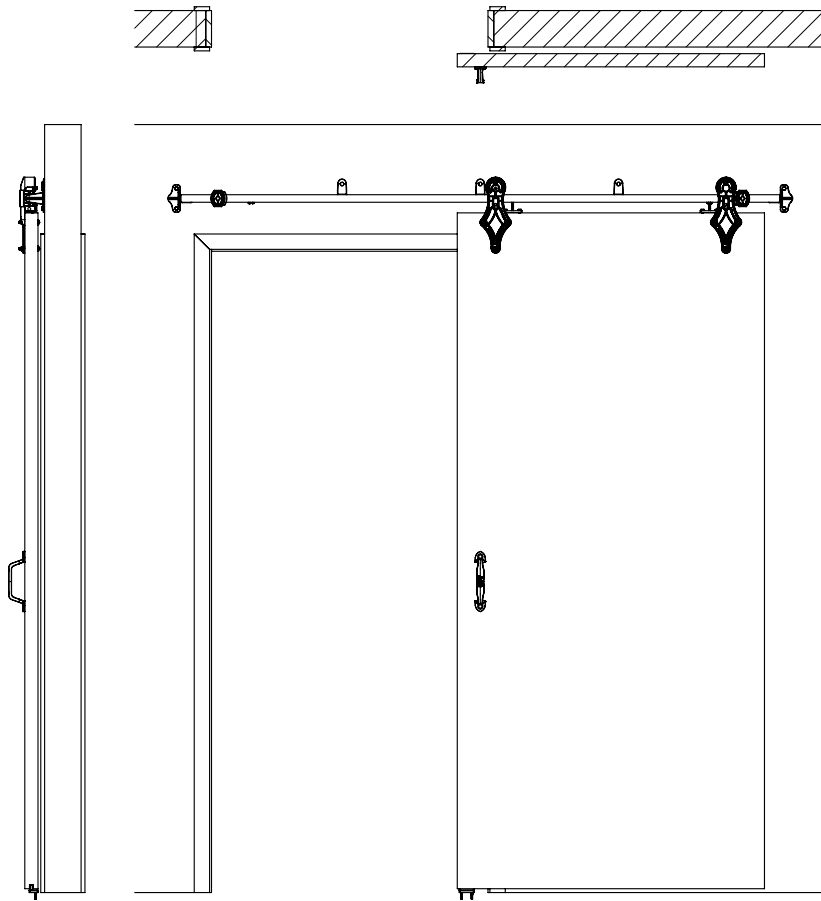

No.101 Track System

Our standard systems require minimal assembly and are simple to install. For applications where a custom length is required the tracks can easily be cut to the desired length by the installation technician. Optional parts and accessories which coordinate with our No.108 sliding door track systems can be purchased separately.

Included Parts and Assemblies

No.1 sliding track assembly compatible with 1" track, cast iron 2" offset mounting brackets and installation hardware.

No.1 Cast Iron Door hangers for No.1 track

No.50 Door guide with center blade for doors less than 175lbs

Installation hardware

Optional Accessories

Item#	Color	Description
380-30-121	Satin Black	No.305 Raised Door Pull
380-31-121	Satin Brass	No.305 Raised Door Pull, Min. order quantity 100 pcs.
380-30-221	Satin Black	No.306 Flush door pull
380-31-221	Satin Brass	No.306 Flush door pull, Min. order quantity 100 pcs.

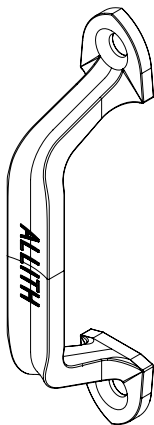

380-30-121
380-31-121

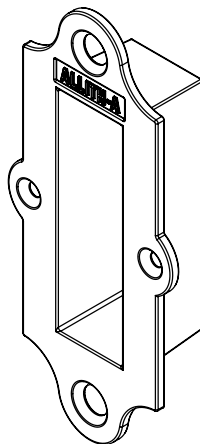

380-30-221
380-31-221

